

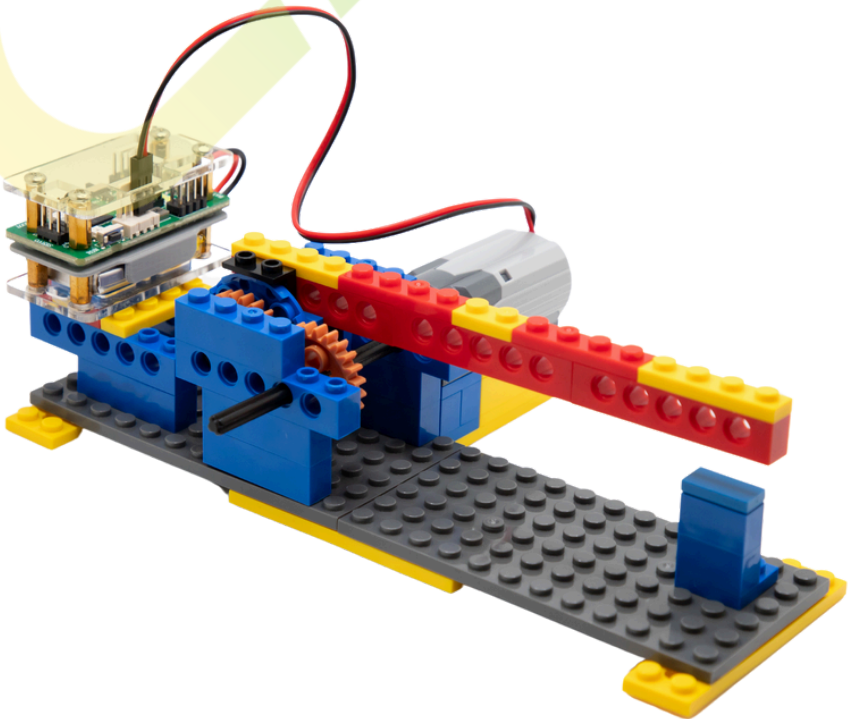

Student Instruction Manual

Railroad Gate Lever





All Parts Required

Check for all Gate Lever parts:



1x
99781
Black

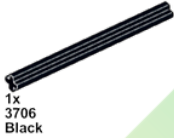

1x
3706
Black

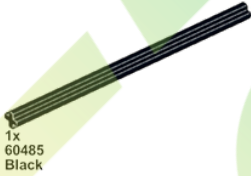

1x
60485
Black

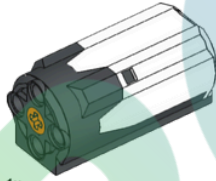

1x
58120c01
White

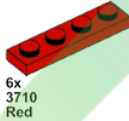

6x
3710
Red

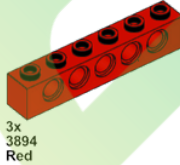

3x
3894
Red



2x
3648
Nougat



1x
4265c
Bright Light Orange



2x
3023old
Bright Light Orange



4x
3710
Bright Light Orange

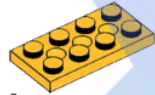

2x
3709b
Bright Light Orange

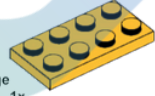

1x
3020
Bright Light Orange

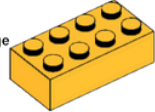

1x
3001
Bright Light Orange

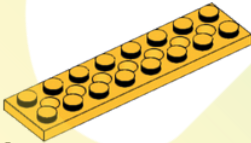

5x
3738
Bright Light Orange



3x
3022
Blue



2x
3069
Blue



3x
3004
Blue



1x
3065
Blue

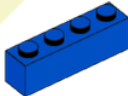

8x
3010
Blue



2x
60474
Blue



4x
3894
Blue

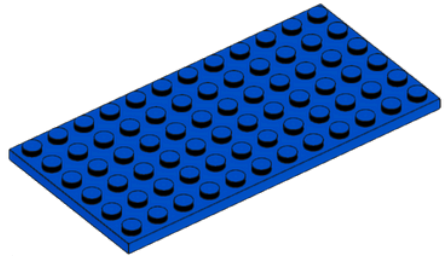

2x
3028
Blue





Building Steps

1

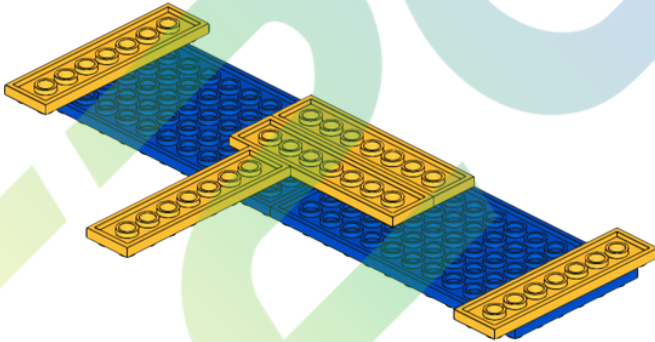
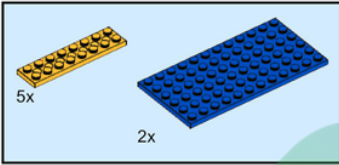

2

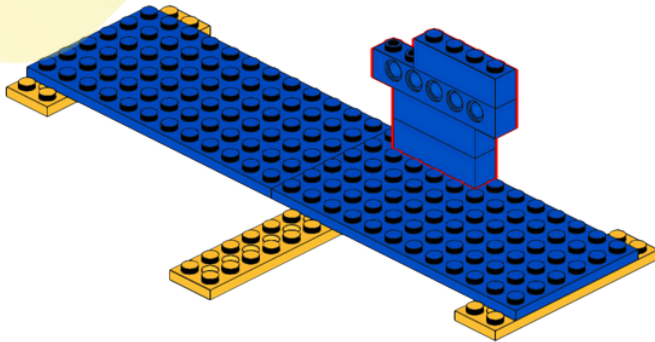
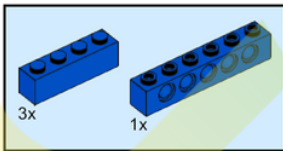



Building Steps

3

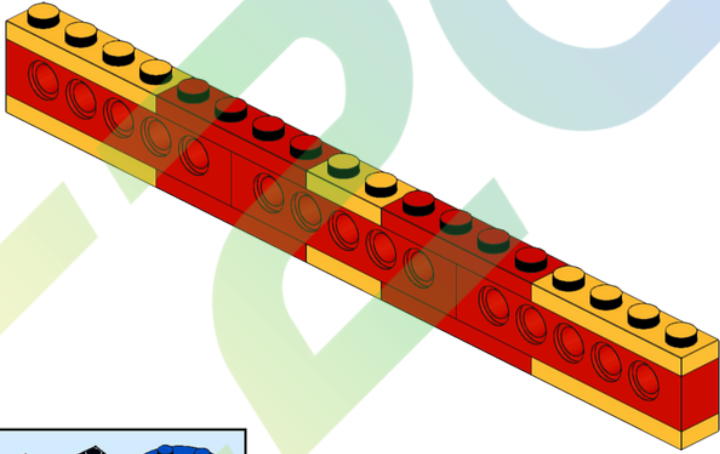
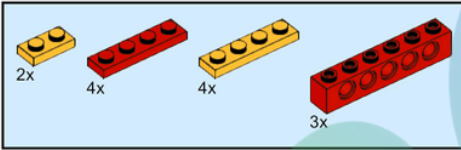

4

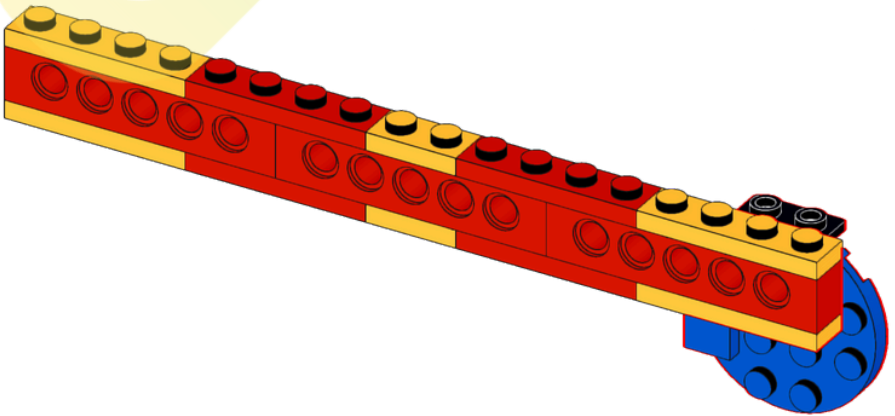
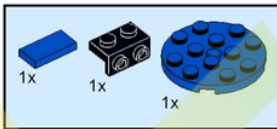



Building Steps

5

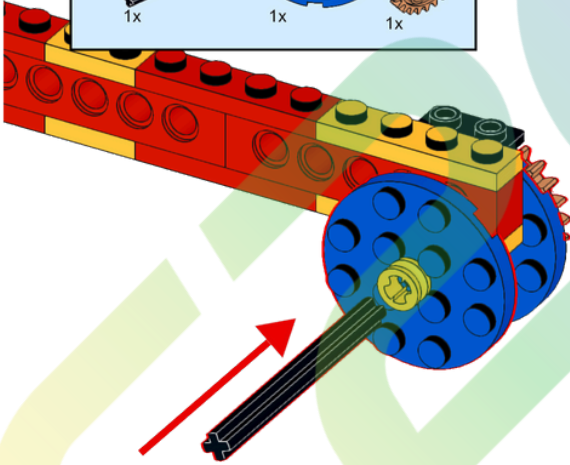
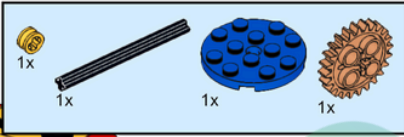

6

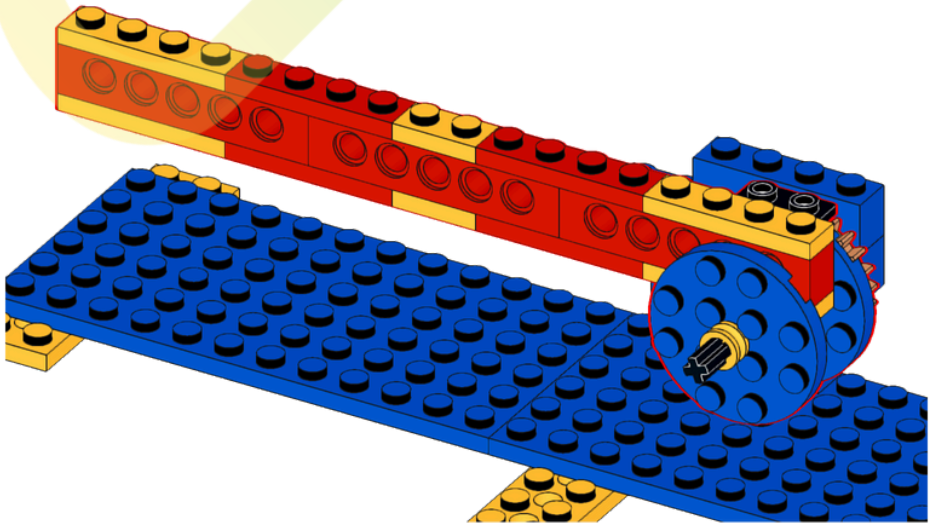



Building Steps

7

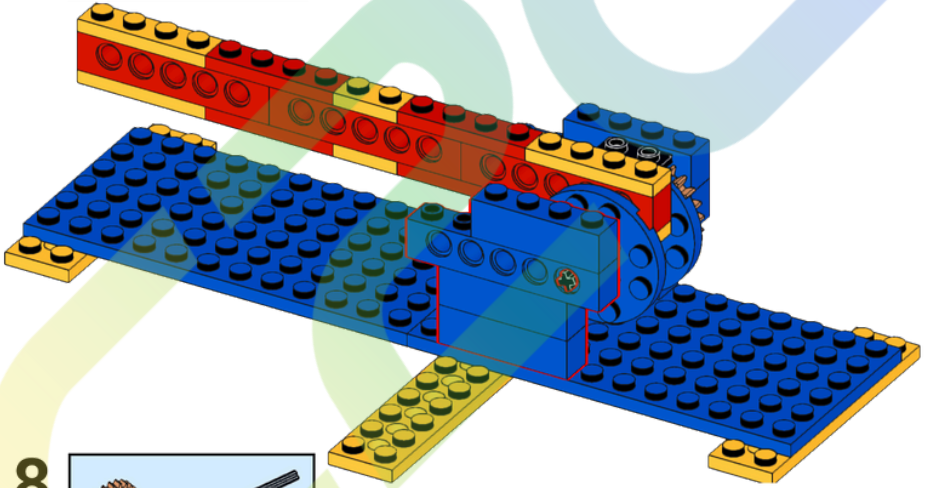
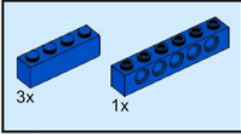

8

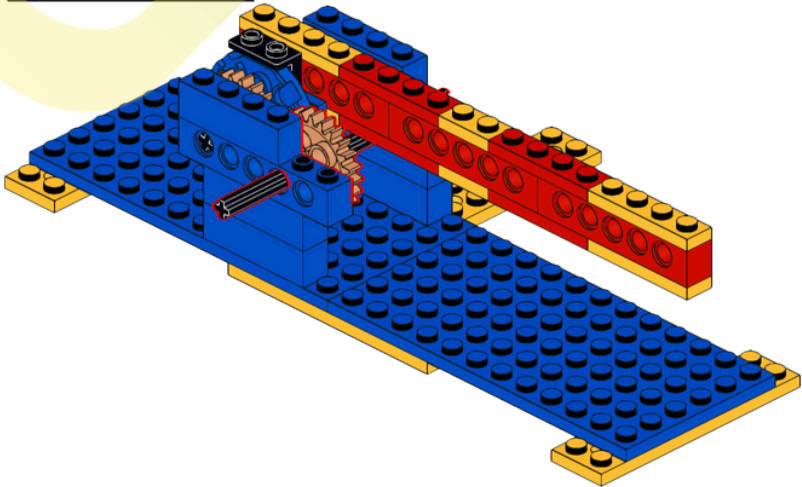
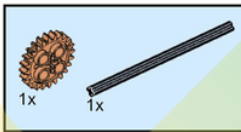



Building Steps

9

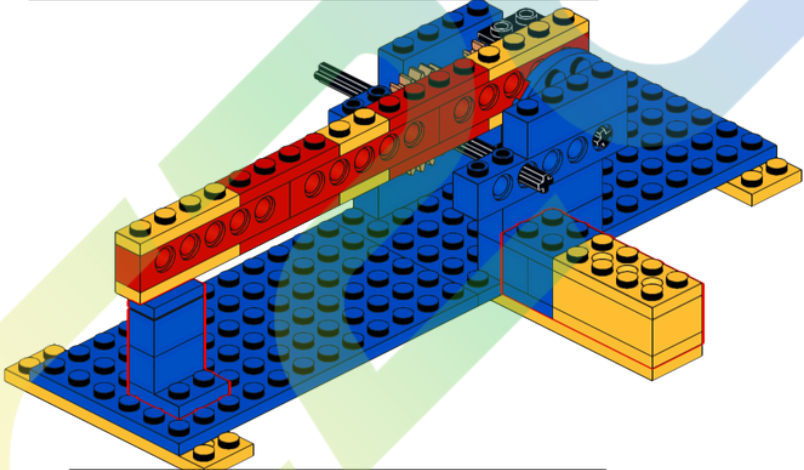
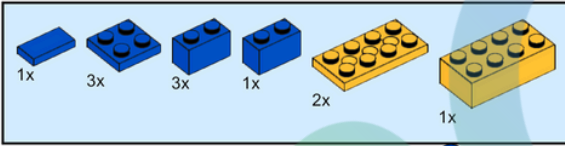

10

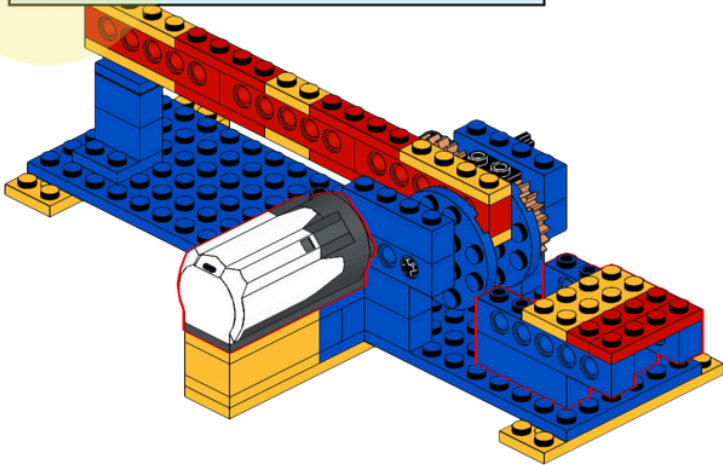
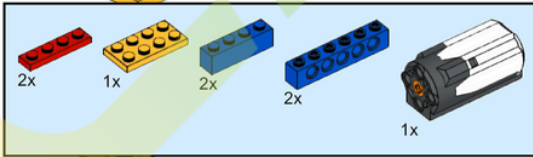



Mounting the Microcontroller

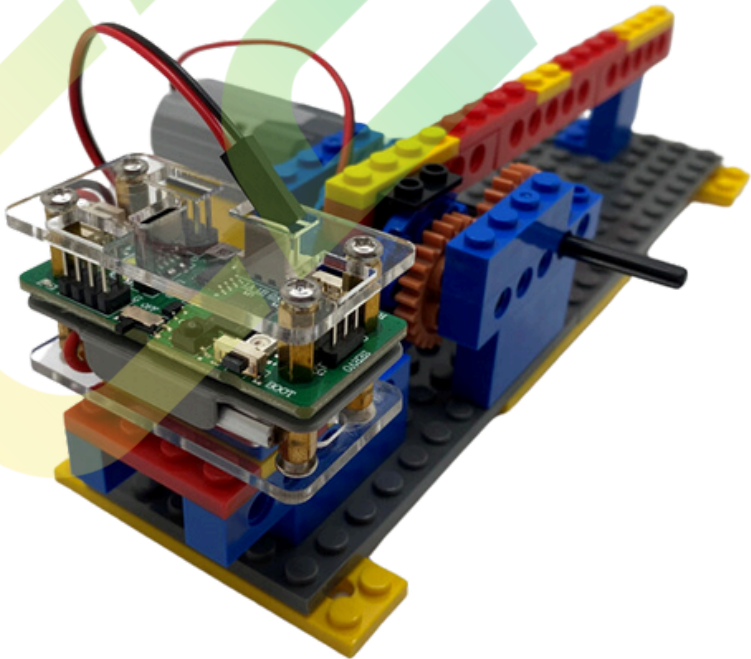



How to wire the robot?

C2G Mini Wiring Schematics

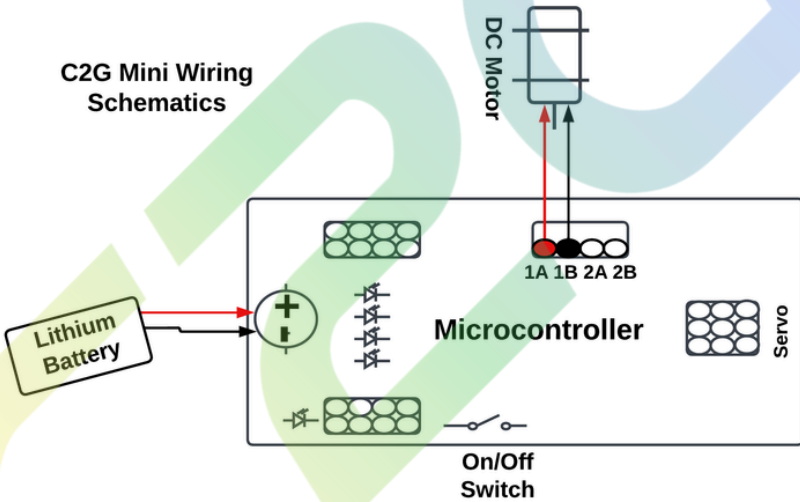

1A: Red wire of DC motor
1B: Black wire of DC motor

Lithium Battery Wiring

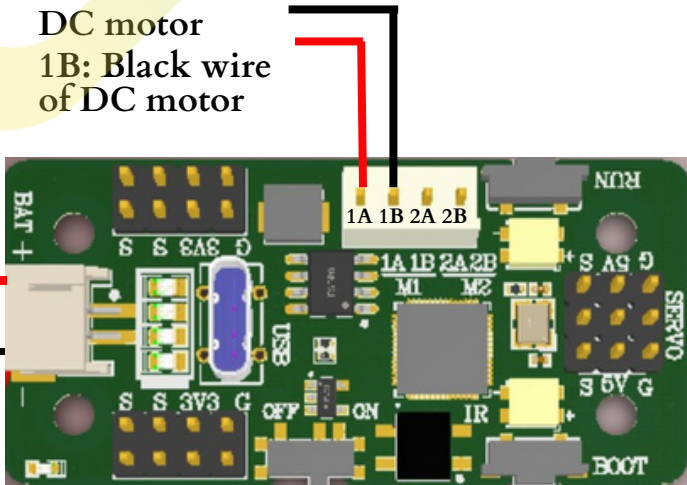



Congratulations on
completing the
Railroad Gate Lever build!

